

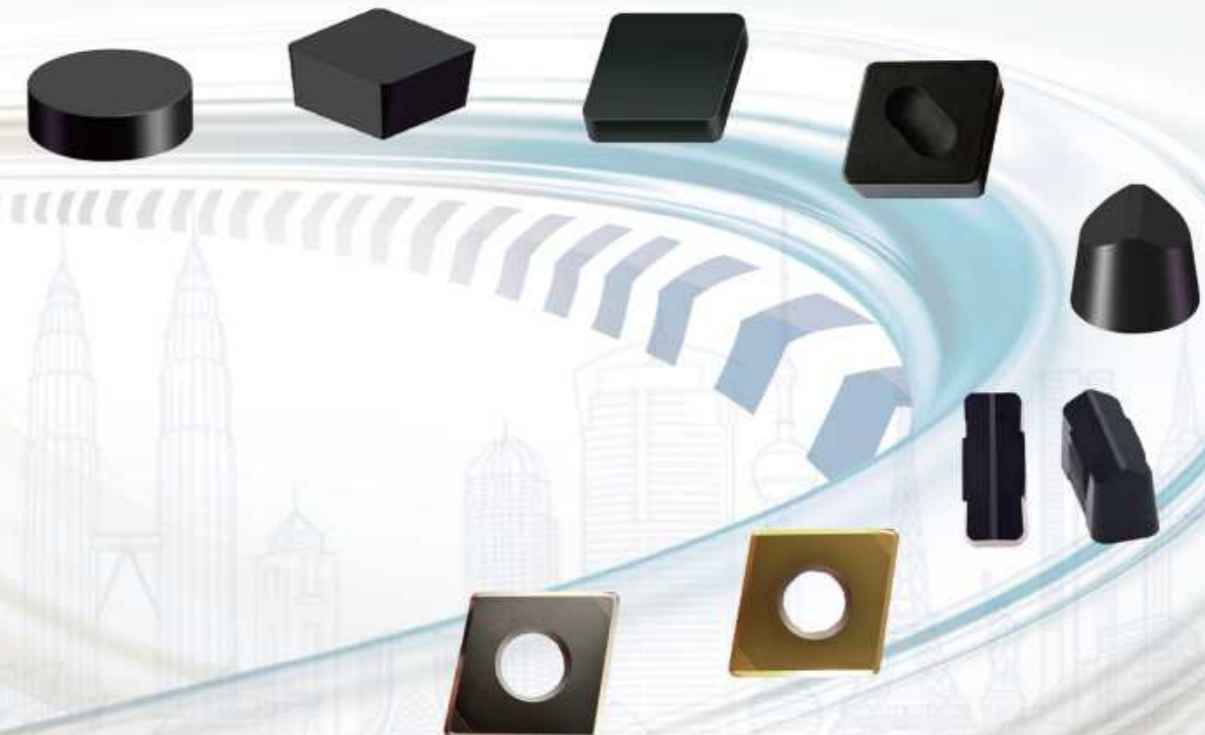

PROFESSIONAL MANUFACTURER

OF CBN MATERIALS R & D
AND CUTTING TOOLS PRODUCTION

HENAN WEGCL NEW MATERIALS CO.LTD



HENAN WEGCL NEW MATERIALS CO.LTD

 Add | NO.13 JINXIU RD, ERQI DISTRICT, 450052, HENAN, CHINA

 Tel | +86 371-56705820

 Fax | +86 371-56705820

 Email | info@scbntools.com/scbntools@gmail.com

 Web | www.scbntools.com

ENTERPRISE INTRODUCTION

SCBN TOOL is a professional manufacturer specializing in the production of superhard materials and cutting tools. We have a National Key Laboratory of superhard materials, which focus on the basic research of superhard materials, solve major scientific and application problems in the World-Class modernization construction and frontier fields, and have achieved many international and domestic leading scientific achievements. Focus on the research and development of CBN tools .we master China's top super hard materials and manufacturing technology of super hard tools.

SCBN series ultra-hard cutting tools have unique advantages in cutting ultra-high hardness materials, and continue to provide high-speed, efficient, green and environmental friendly heavy-duty cutting tools and precision cutting tools for manufacturing industry.



PRODUCT INTRODUCTION



CNGN



SNMN



RNMN



RCGV



SCGN



CNGL



CNGL



CNGS



CNGX



CNMA



DNGX



DNMA



SNGS



SNGX



SNMA



VNGL



WNGA



TNGA



CNGA



Chipbreaker PCBN Inserts



Chipbreaker PCBN Inserts



CNGA



DNGA



CBN Grooving Inserts



CBN Grooving Inserts



CBN Grooving Inserts

CBN GRADE AND APPLICATION

Insert Image	CBN Grade	CBN Content	Granular μm	Binder	Machining Condition	Machining Materials	Application Industry
	SBN800	80%	5~10	Metal	Roughing, Semi-Finishing	Hardened Steel	Gears, Bearings,ect
	SBN830	70%	1~5	Metal	Roughing,Semi-Finishing	Hardened Steel	Gears, Bearings,ect
	SBN850	95%	5~15	Metal	Roughing,Semi-Finishing	Gray Cast Iron	Brake Drum,Brake Disc Engine Block, Cylinder Liner,ect
	SBN900	90%	15~25	Ceramic	Roughing, Semi-Finishing	Chilled Cast Iron, Cast Steel High Manganese Steel	Rolls,Crusher Cone Grinding Roller,ect
	SBN950	85%	15~25	Metal	Roughing, Semi-Finishing	Chilled Cast Iron Alloy Cast iron High Speed Steel	Impeller,Pump Body Pump Housing,Liner Roller,ect
	SBN600	75%	5~10	Ceramic	Roughing, Semi-Finishing	Ductile Iron	Hub unit Drive Shaft ,ect
	SBH130	70~85%	1~2	Ceramic	Continuous Light Interrupt	Hardened Steel	Gears,Bearings,ect
	SBH170	55~60%	1~2	Metal	Light Interrupt Mid Interrupt	Hardened Steel	Ball screw,Bearing, Transmission Shaft, Gears ,ect
	SBH190	65~70%	1~2	Metal	Heavy Interrupt	Hardened Steel	Ball screw, Bearing, Transmission Shaft, Gears,ect
	SBH560	60~65%	1~2	Metal	Continuous Light Interrupt Mid Interrupt	Hardened Steel	Ball screw,Bearing, Transmission Shaft, Gears ect
	SBH570	65~70%	1~2	Metal	Mid Interrupt Heavy Interrupt	Hardened Steel	Ball screw,Bearing, Transmission Shaft, Gears ect
	SBK130	90%	1~5	Metal	Continuous Interrupt	Gray Cast Iron	Cylinder liner,engine block,wheel hub,etc
	SBK170	75%	1~2	Ceramic	Continuous Interrupt	Ductile Iron	Bearings,Shaft, Hub Unit Drive Shaft

Grade	Color	Material Composition	Thickness	Application	Advantage	Image For Reference
S1	Gold	TiSiN	2-5 μm	Hard steel Cast iron	Excellent surface roughness and stability	
S2	Copper	AlCrN	2-5 μm	Hard steel	High wear resistance and high stability	
S3	Purple	TiCrN	5-10 μm	Hard steel	Excellent heat resistance and collapse resistance	
S4	Sliver	TiAlN	5-10 μm	Hard steel Ductile iron	Excellent impact resistance under high-speed heavycutting	

CBN CUTTING PARAMETERS FOR REFERENCE

Machining Materials	Machining Process	Advised Cutting Parameters		
		Cutting Speed Vc (m/min)	Cutting Depth a (mm)	Feed Rate Fr (mm/r)
High Hardness Cast Iron (Hardness:HRC35-68)	Roughing	35-120	1-5	0.15-1.0
	Finishing	60-200	<1	0.05-0.35
Hardened Steel (Hardness>HRC45)	Roughing	50-150	1-5	0.1-0.5
	Finishing	90-250	<1	0.05-0.35
Gray Cast Iron	Roughing	400-1200	1-5	0.2-1.0
	Finishing	600-1500	<1	0.05-0.3

SCBN TOOLS CUTTING PARAMETERS REFERENCE

Materials	Component Hardness	Cutting Speed m/min	Depth of Cut/mm	Feed Rate/Fr
Gray Cast Iron	HB170~HB300	500~2000	0.5~2.0	0.1~0.2
High Hardness Cast Iron	HRC55	80~300	0.5~5.0	0.1~1
Hardened Steel	HRC45~HRC68	80~200	<0.5	0.05~0.5

CBN CUTTING TOOLS NAMING STANDARD

Shape Code	Inserts	Shape	Angle
S		square	90°
T		regular triangle	60°
C		rhombus (diamond)	80°
D			55°
E			75°
M			86°
V			35°
W		chimb triangle	80°
H		regular hexagon	120°
O		regular octagon	135°
P		regular pentagon	108°
L		rectangle	90°
A		parallelogram	85°
B			82°
N/K			55°
R		round	-

Insert Shape

Tolerance							
Code	Tip Height Tolerance (mm)	Inscribed circle Ic Tolerance (mm)	Thickness S Tolerance (mm)	Code	Tip Height Tolerance (mm)	Inscribed circle Ic Tolerance (mm)	Thickness S Tolerance (mm)
A	±0.005	±0.025	±0.025	J	±0.005	±0.05-±0.13	±0.025
F	±0.005	±0.013	±0.025	K	±0.013	±0.05-±0.13	±0.025
C	±0.013	±0.025	±0.025	L	±0.025	±0.05-±0.13	±0.025
H	±0.013	±0.013	±0.025	M	±0.08-±0.18	±0.05-±0.13	±0.13
E	±0.025	±0.025	±0.025	N	±0.08-±0.18	±0.05-±0.13	±0.025
G	±0.025	±0.025	±0.13	U	±0.13-±0.38	±0.08-±0.25	±0.13

Tolerance

Inscribed Circle (mm)	Cutting Edge length (mm)						
	C	D	S	T	V	W	R
3.97				06			03
4.76				08			04
5.0							05
5.56				09	09		05
6.0							06
6.35	06	07	06	11	11	04	06
7.94	08	09					07
8.0							08
9.525	09	11	09	16	16	06	09
10.0							10
12.0							12
12.7	12	15	12	22	22	08	12
15.875	16		15	27			15
16.0		19					16
19.05	19		19	33			19
20.0							20
25.0	25	25					25
25.4			25				25
31.75							31
32							32

Insert Size

Code	Tip Radius Arc (mm)
00	Sharp or Round insert
02	0.2
04	0.4
08	0.8
12	1.2
16	1.6
20	2.0
24	2.4
32	3.2
X	Other

Tips Radius

V : Pyramid Bottom	Y : Cone Bottom
<p>V means pyramid bottom, the figures 135 means the pyramid angle is 135°. It can be blank if pyramid angle is 120°. For example: the model of the insert with pyramid angle is RCMX120700V. It can also be written as RCMX120700V with 120°. But it must be written out clearly if the pyramid angle is not 120°. For example: the model of the insert with 135 pyramid angle is RCMX120700V135.</p>	<p>Y means cone bottom, the figures 135 means the cone angle is 135°. It can be blank if cone angle is 120°. For example: the model of the insert with cone angle is RCMX120700Y. It can also be written as RCMX120700Y120. But it must be written out clearly if the cone angle is not 120°. For example: the model of the insert with 135 cone angle is RCMX120700Y135.</p>

Pyramid Cone Bottom

R C M X
C N G A

09 07 00 T02020 Y135
12 04 08 T 020 20 -2N

Clerance Angle	
Code	Clerance angle
N	
A	
B	
C	
P	
D	
E	
F	
G	
O	

Chipbreaker and Fixing Form							
Code	With or Without hole	Chipbreaker	Sketch	Code	With or Without hole	Chipbreaker	Sketch
N	without	without		B	70°-90° couter bore on single side	without	
R		single side with chipbreaker		H		single side with chipbreaker	
F		both side with chipbreaker		C	70°-90° couter bore on both side	without	
A	round straight hole	without		J		both side with chipbreaker	
M		single side with chipbreaker		O	conceve	round	
G		both side with chipbreaker		S		square	
W	40°-60° couter bore on single side	without		L	long strip		
T		single side with chipbreaker					
Q	40°-60° couter bore on both side	without					
U		both side with chipbreaker					
X	Other fixing on chip breaker types, the drawing and more information to be provided.						

Thickness			
Code	Thickness (mm)	Code	Thickness (mm)
01	1.59	06	6.35
T1	1.98	07	7.94
02	2.38	08	8.0
T2	2.58	09	9.52
03	3.18	10	10.0
T3	3.97	11	11.11
04	4.76	12	12.0
05	5.56	12	12.70

Cutting Edge Form		
Code	Cutting edge form	Drawing
F	Sharp cutting edge	
E	Honing by air cutting edge condition	
T	The negative land cutting edge condition	
S	The negative land and honing cutting edge condition	

Chamfer width (mm)	
Code	Dimension
010	0.10
015	0.15
020	0.20
025	0.25
030	0.30
050	0.50
100	1.00
200	2.00

Chamfer angle (mm)	
Code	Angle
05	5°
10	10°
15	15°
20	20°
25	25°
30	30°

Cutting edge qty	
Code	Qty
1N	1
2N	2
3N	3
4N	4
6N	6
8N	8

ALL DIFFERENT CHAMFER CAN BE OFFERED AS CUSTOMIZED REQUIREMENTS.

Solid PCBN Insert Series

SNMN/SNGN Series (90° Square)

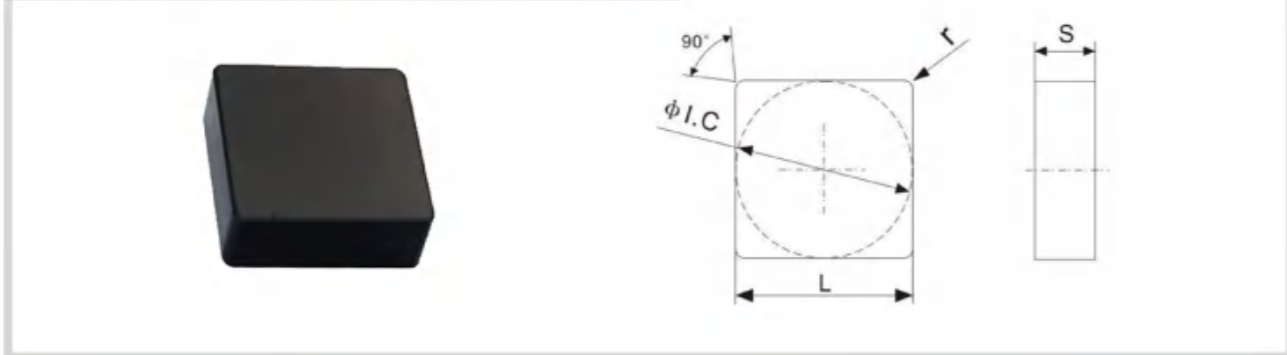

ISO SNMN/SNGN	Dimension				Standard Chamfer
	L(mm)	φ I.C(mm)	S(mm)	r(mm)	
SNMN090304	9	9.525	3.18	0.4	S01020 S02020 S03020 S05020
SNMN090308	9	9.525	3.18	0.8	
SNMN090312	9	9.525	3.18	1.2	
SNMN090404	9	9.525	4.76	0.4	
SNMN090408	9	9.525	4.76	0.8	
SNMN090412	9	9.525	4.76	1.2	
SNMN120404	12	12.7	4.76	0.4	
SNMN120408	12	12.7	4.76	0.8	
SNMN120412	12	12.7	4.76	1.2	
SNMN120712	12	12.7	7.94	1.2	
SNMN120716	12	12.7	7.94	1.6	
SNMN150716	15	15.875	7.94	1.6	
SNMN201020	20	20	10	2.0	

CNMN/CNGN Series (80° rhombic)

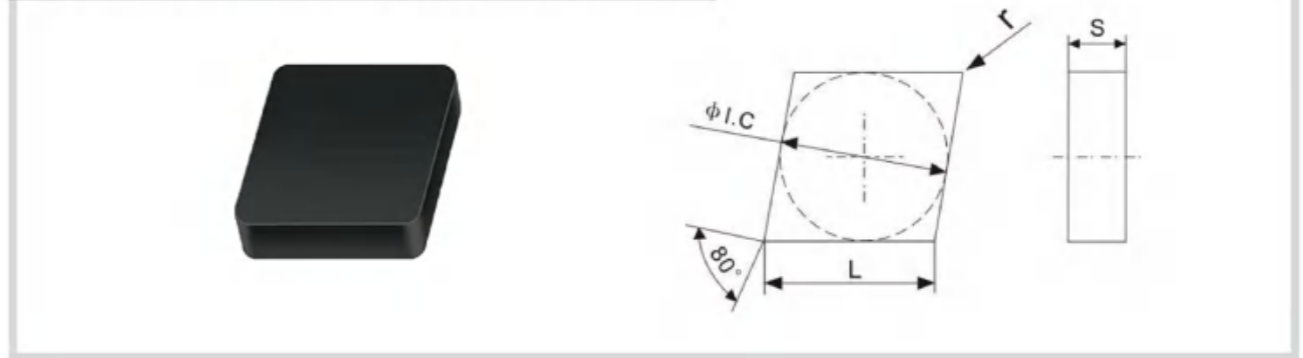

ISO CNMN/CNGN	Dimension				Standard Chamfer
	L(mm)	φ I.C(mm)	S(mm)	r(mm)	
CNMN090404	9	9.525	4.76	0.4	S01020 S02020 S03020 S05020
CNMN090408	9	9.525	4.76	0.8	
CNMN090412	9	9.525	4.76	1.2	
CNMN120404	12	12.7	4.76	0.4	
CNMN120408	12	12.7	4.76	0.8	
CNMN120412	12	12.7	4.76	1.2	
CNMN120416	12	12.7	4.76	1.6	
CNMN120704	12	12.7	7.94	0.4	
CNMN120708	12	12.7	7.94	0.8	
CNMN120712	12	12.7	7.94	1.2	
CNMN120716	12	12.7	7.94	1.6	
CNMN150716	15	15.875	7.94	1.6	
CNMN201020	20	20	10	2.0	

RNMN/RNGN Series (Round)

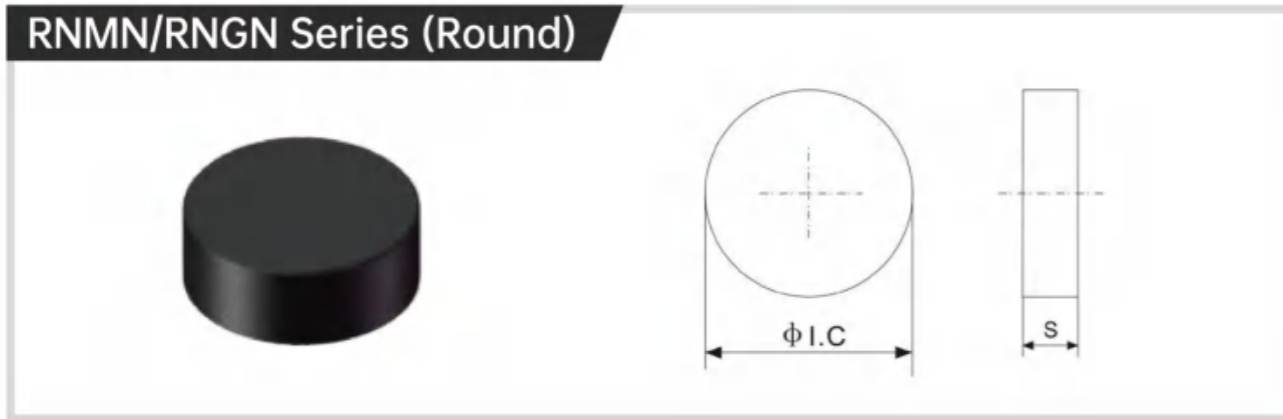

ISO RNMN/RNGN	Dimension				Standard Chamfer
	L(mm)	φ I.C(mm)	S(mm)	r(mm)	
RNMN060400	6	6.35	4.76	/	S02020 S03020 S05020 S10020
RNMN090300	9	9.525	3.18	/	
RNMN090400	9	9.525	4.76	/	
RNMN090700	9	9.525	7.94	/	
RNMN120400	12	12.7	4.76	/	
RNMN120600	12	12.7	6.35	/	
RNMN120700	12	12.7	7.94	/	
RNMN150700	15	15.875	7.94	/	
RNMN200800	20	20	8	/	
RNMN201000	20	20	10	/	
RNMN251000	25	25.4	10	/	
RNMN251200	25	25.4	12	/	

TNMN/TNGN Series (60° Triangle)

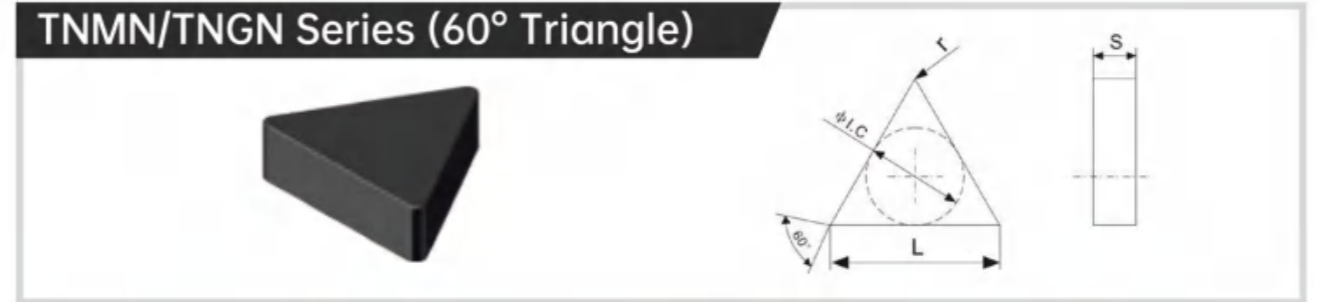

ISO TNMN/TNGN	Dimension				Standard Chamfer
	L(mm)	φ I.C(mm)	S(mm)	r(mm)	
TNMN110304	11	6.35	3.18	0.4	S01020 S02020
TNMN110308	11	6.35	3.18	0.8	
TNMN110312	11	6.35	3.18	1.2	
TNMN160404	16	9.525	4.76	0.4	
TNMN160408	16	9.525	4.76	0.8	
TNMN160412	16	9.525	4.76	1.2	

DNMN/DNGN Series (55° Rhombic)

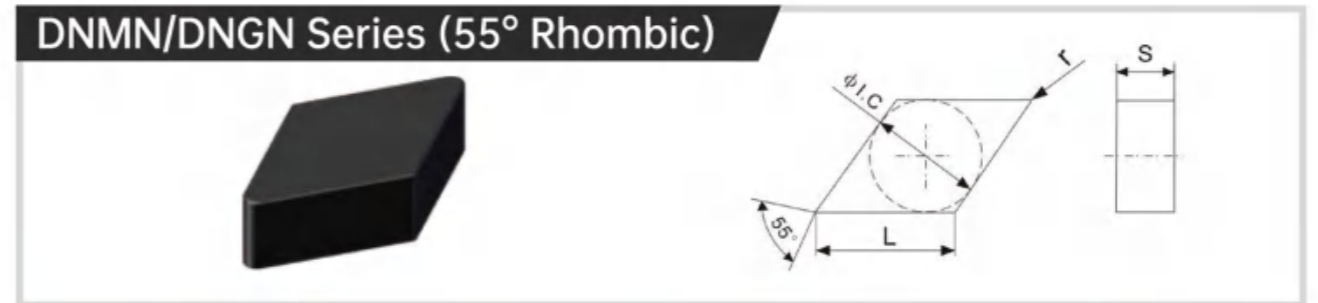

ISO DNMN/DNGN	Dimension				Standard Chamfer
	L(mm)	φ I.C(mm)	S(mm)	r(mm)	
DNMN110404	11	9.525	4.76	0.4	S02020 S03020
DNMN110408	11	9.525	4.76	0.8	
DNMN110412	11	9.525	4.76	1.2	
DNMN150404	15	12.7	4.76	0.4	
DNMN150408	15	12.7	4.76	0.8	
DNMN150412	15	12.7	4.76	1.2	
DNMN150416	15	12.7	4.76	1.6	

SCGN Series (90° Square with 7° relief angle)

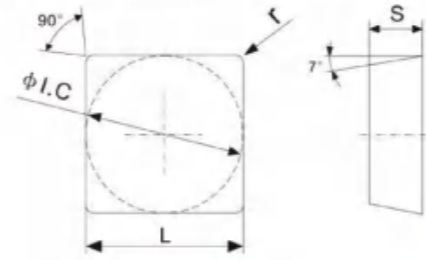

ISO SCGN	Dimension				Standard Chamfer
	L(mm)	φ I.C(mm)	S(mm)	r(mm)	
SCGN090304	9	9.525	3.18	0.4	S01020 S02020
SCGN090308	9	9.525	3.18	0.8	
SCGN090312	9	9.525	3.18	1.2	
SCGN090404	9	9.525	4.76	0.4	
SCGN090408	9	9.525	4.76	0.8	
SCGN090412	9	9.525	4.76	1.2	

RCMN/RCGN Series (Round with 7° relief angle)

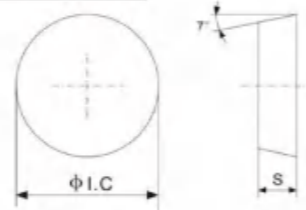

ISO RCMN	Dimension				Standard Chamfer
	L(mm)	φ I.C(mm)	S(mm)	r(mm)	
RCMN060400	6	6.35	4.76	/	S02020 S03020 S05020 S10025
RCMN090400	9	9.525	4.76	/	
RCMN090700	9	9.525	7.94	/	
RCMN120700	12	12.7	7.94	/	
RCMN150700	15	15.875	7.94	/	
RCMN190700	19	19.05	7.94	/	

WNMN/WNGN Series (80° Peach)

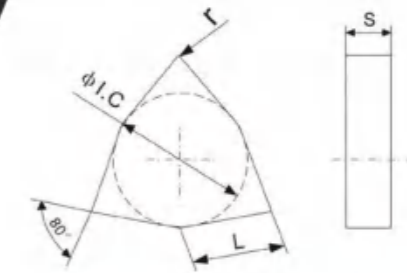

ISO WNMN/WNGN	Dimension				Standard Chamfer
	L(mm)	φ I.C(mm)	S(mm)	r(mm)	
WNMN080404	8	12.7	4.76	0.4	S02020 S03020
WNMN080408	8	12.7	4.76	0.8	
WNMN080412	8	12.7	4.76	1.2	

RCMX/RCGX Series (Round with 7° relief angle)

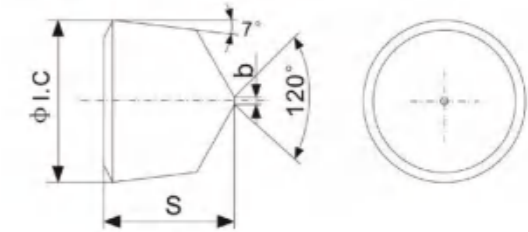
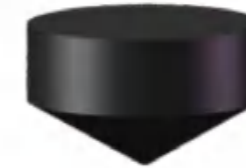

ISO RCMX	Dimension				Standard Chamfer
	L(mm)	φ I.C(mm)	S(mm)	r(mm)	
RCMX060400	6	6.35	4.76	/	S02020 S03020 S05025 S10025 S20020
RCMX060500	6	6.35	5.56	/	
RCMX060600	6	6.35	6.35	/	
RCMX060700	6	6.35	7.94	/	
RCMX090700	9	9.525	7.94	/	
RCMX120700	12	12.7	7.94	/	
RCMX151000	15	15.875	10	/	
RCMX191000	19	19.05	10	/	
RCMX201200	20	20	12	/	
RCMX251200	25	25.4	12	/	

RCMV/RCGV Series (Round with 7°relief angle)

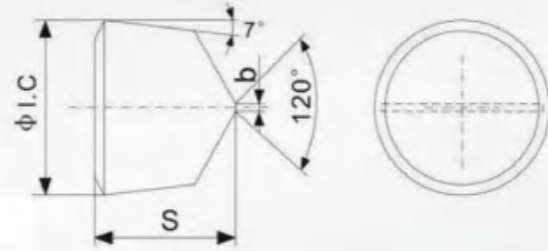

ISO RCMV/RCGV	Dimension				b(mm)	Standard Chamfer
	L(mm)	ϕ I.C(mm)	S(mm)	r(mm)		
RCMV060400	6	6.35	4.76	/	0.8	S02020 S03020 S05025 S10025 S20020
RCMV060500	6	6.35	5.56	/	0.8	
RCMV060600	6	6.35	6.35	/	0.8	
RCMV090700	9	9.525	7.94	/	1	
RCMV120700	12	12.7	7.94	/	2	
RCMV151000	15	15.875	10	/	2	
RCMV191000	19	19.05	10	/	2	
RCMV201200	20	20	12	/	2	
RCMV251200	25	25.4	12	/	2	

Application Area:

H,K,P(H-refer to Hard Steel,K-refer to Cast Iron,P-refer to Alloy Steel)

VARIOUS CUSTOMIZED SOLID CBN INSERTS

We can offer various type Solid CBN Inserts as customized requirements, such as Dimple, Hole, Wiper, Chipbreaker, Grooving Inserts,ect. Besides, we also can offer coating Service on all type solid cbn insert.

Various Solid CBN Inserts with Dimple

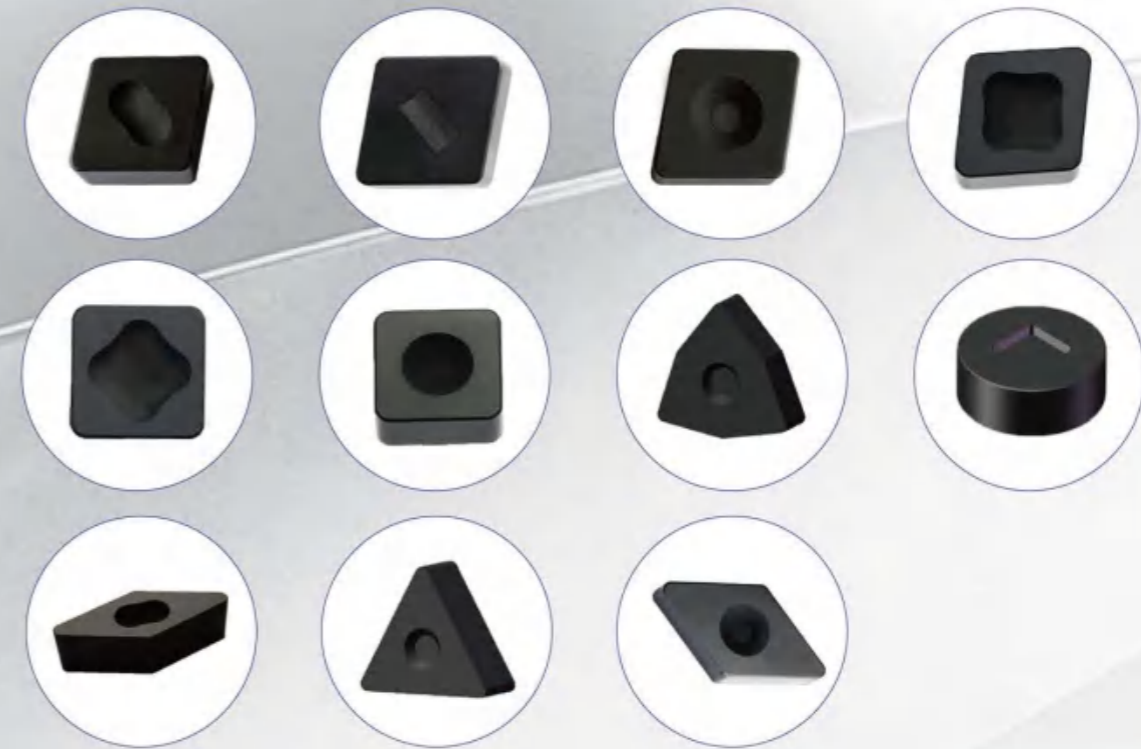

Various Solid CBN Inserts with hole

Various Solid CBN Grooving Inserts

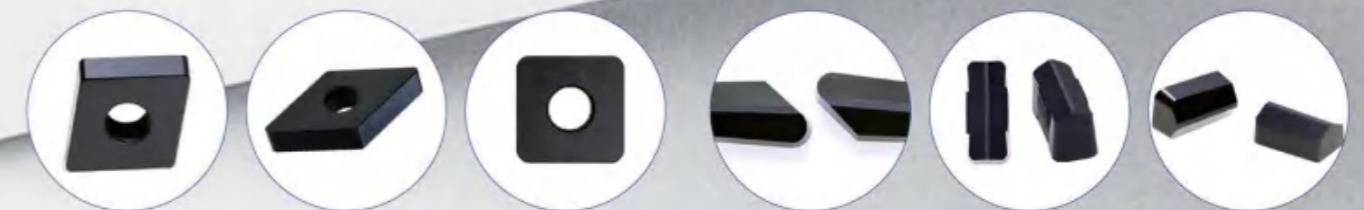

Brazed PCBN Insert Series

CNGA Series (80° Rhombic)

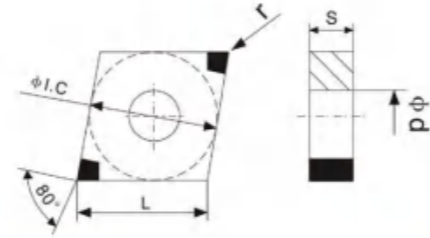

ISO	Dimension					Standard Chamfer
	L(mm)	ϕ I.C(mm)	S(mm)	ϕ d(mm)	r(mm)	
CNGA120404-4N	12	12.7	4.76	5.16	0.4	S01020 S02020
CNGA120408-4N	12	12.7	4.76	5.16	0.8	
CNGA120412-4N	12	12.7	4.76	5.16	1.2	
CNGA120416-4N	12	12.7	4.76	5.16	1.6	

DNGA Series (55° Rhombic)

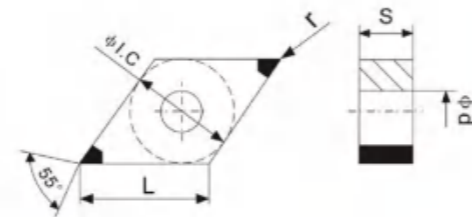
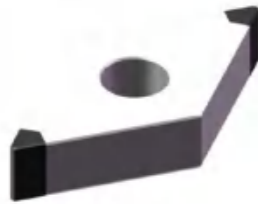

ISO	Dimension					Standard Chamfer
	L(mm)	ϕ I.C(mm)	S(mm)	ϕ d(mm)	r(mm)	
DNGA150404-4N	15	12.7	4.76	5.16	0.4	S01020 S02020
DNGA150408-4N	15	12.7	4.76	5.16	0.8	
DNGA150412-4N	15	12.7	4.76	5.16	1.2	
DNGA150604-4N	15	12.7	6.35	5.16	0.4	
DNGA150608-4N	15	12.7	6.35	5.16	0.8	
DNGA150612-4N	15	12.7	6.35	5.16	1.2	

TNGA Series (60° Triangle)

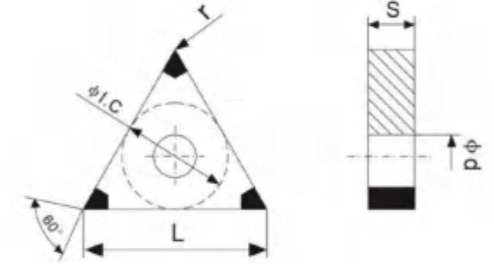
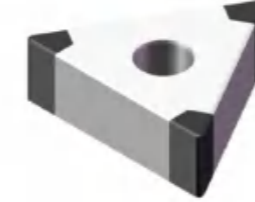

Type	Dimension					Standard Chamfer
	L(mm)	ϕ I.C(mm)	S(mm)	ϕ d(mm)	r(mm)	
TNGA160404-6N	16	9.525	4.76	3.81	0.4	S01020 S02020
TNGA160408-6N	16	9.525	4.76	3.81	0.8	
TNGA160412-6N	16	9.525	4.76	3.81	1.2	

WNGA Series (80° Peach)

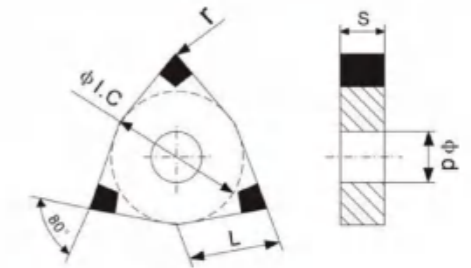
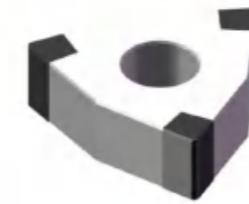

ISO	Dimension					Standard Chamfer
	L(mm)	ϕ I.C(mm)	S(mm)	ϕ d(mm)	r(mm)	
WNGA080404-6N	8	12.7	4.76	5.16	0.4	S01020 S02020
WNGA080408-6N	8	12.7	4.76	5.16	0.8	
WNGA080412-6N	8	12.7	4.76	5.16	1.2	

VNGA Series (35° Rhombic)

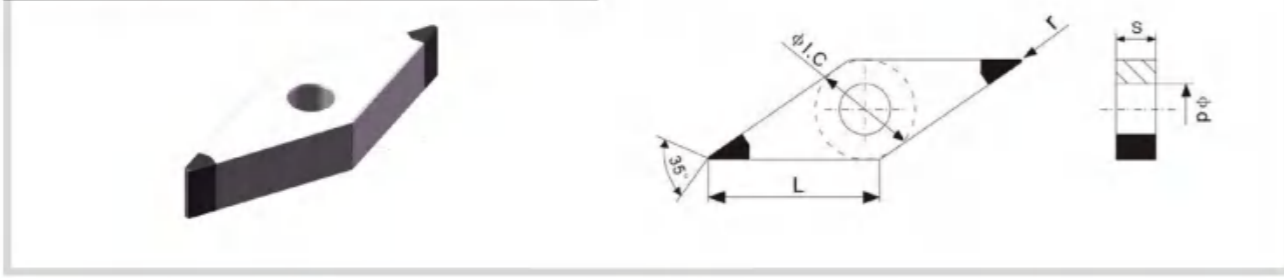

Type	Dimension					Standard Chamfer
	L(mm)	φ I.C(mm)	S(mm)	φ d(mm)	r(mm)	
VNGA160404-4N	16	9.525	4.76	3.81	0.4	S01015 S01020 S01025 S02020
VNGA160408-4N	16	9.525	4.76	3.81	0.8	
VNGA160412-4N	16	9.525	4.76	3.81	1.2	

◆ Note: Chamfer can be customized.

DNGA Series (55° Rhombic)



ISO	Dimension					Standard Chamfer
	L(mm)	φ I.C(mm)	S(mm)	φ d(mm)	r(mm)	
DNGA150404-2N/4N	15	12.7	4.76	5.16	0.4	S01020 S01025 S02020 S03020
DNGA150408-2N/4N	15	12.7	4.76	5.16	0.8	
DNGA150412-2N/4N	15	12.7	4.76	5.16	1.2	
DNGA150604-2N/4N	15	12.7	6.35	5.16	0.4	
DNGA150608-2N/4N	15	12.7	6.35	5.16	0.8	
DNGA150612-2N/4N	15	12.7	6.35	5.16	1.2	

PCBN Tipped Insert Series

CNGA Series (80° Rhombic)

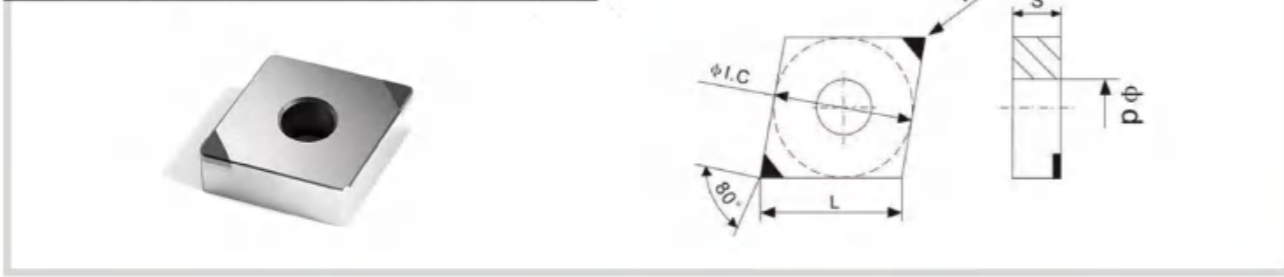

ISO	Dimension					Standard Chamfer
	L(mm)	φ I.C(mm)	S(mm)	φ d(mm)	r(mm)	
CNGA120404-2N/4N	12	12.7	4.76	5.16	0.4	S01020 S01025 S02020 S02025
CNGA120408-2N/4N	12	12.7	4.76	5.16	0.8	
CNGA120412-2N/4N	12	12.7	4.76	5.16	1.2	
CNGA120416-2N/4N	12	12.7	4.76	5.16	1.6	

TNGA Series (60° Triangle)

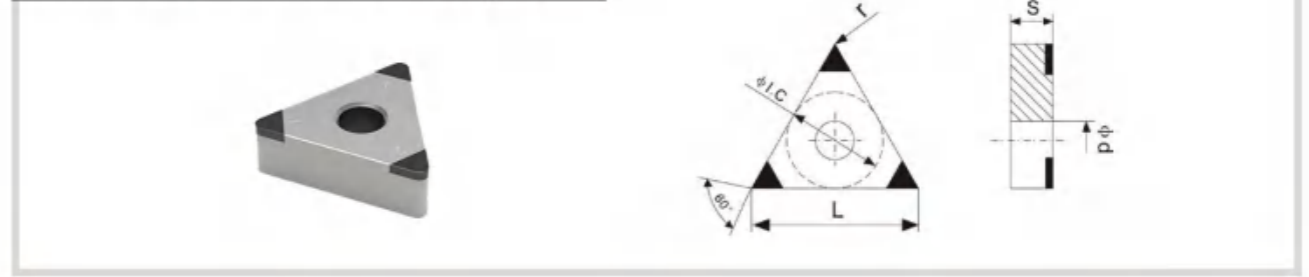

ISO	Dimension					Standard Chamfer
	L(mm)	φ I.C(mm)	S(mm)	φ d(mm)	r(mm)	
TNGA160402-3N/6N	16	9.525	4.76	3.81	0.2	S01020 S01025 S02020 S02025
TNGA160404-3N/6N	16	9.525	4.76	3.81	0.4	
TNGA160408-3N/6N	16	9.525	4.76	3.81	0.8	
TNGA160412-3N/6N	16	9.525	4.76	3.81	1.2	

WNGA Series (80° Peach)

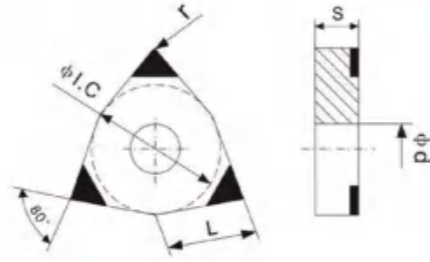
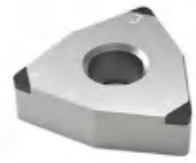

ISO	Dimension					Standard Chamfer
	L(mm)	ϕ I.C(mm)	S(mm)	ϕ d(mm)	r(mm)	
WNGA080404-3N/6N	8	12.7	4.76	5.16	0.4	S01020 S01025 S02020 S02025
WNGA080408-3N/6N	8	12.7	4.76	5.16	0.8	
WNGA080412-3N/6N	8	12.7	4.76	5.16	1.2	

VNGA Series (35° Rhombic)

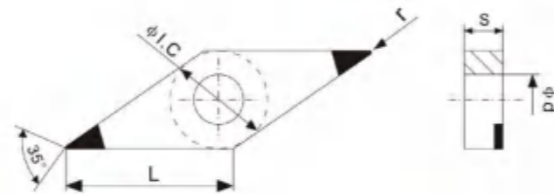

ISO	Dimension					Standard Chamfer
	L(mm)	ϕ I.C(mm)	S(mm)	ϕ d(mm)	r(mm)	
VNGA160402-2N/4N	16	9.525	4.76	3.81	0.2	S01020 S01025 S02020 S02025
VNGA160404-2N/4N	16	9.525	4.76	3.81	0.4	
VNGA160408-2N/4N	16	9.525	4.76	3.81	0.8	
VNGA160412-2N/4N	16	9.525	4.76	3.81	1.2	

SCGW Series with 7° clearance angle

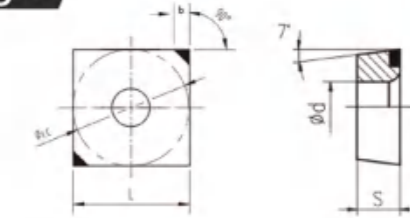

ISO	Dimension					Standard Chamfer
	L(mm)	ϕ I.C(mm)	S(mm)	ϕ d(mm)	r(mm)	
SCGW09T304-2N/4N	9	9.525	3.97	4.4	0.4	S01020 S01025 S02025
SCGW09T308-2N/4N	9	9.525	3.97	4.4	0.8	
SCGW09T312-2N/4N	9	9.525	3.97	4.4	1.2	

CCGW Series (80° Rhombic with 7° relief angle)

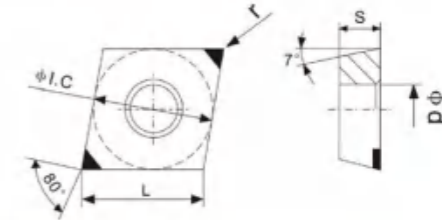
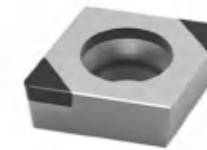

ISO	Dimension					Standard Chamfer
	L(mm)	ϕ I.C(mm)	S(mm)	ϕ d(mm)	r(mm)	
CCGW040102-2N	4.4	4.3	1.8	2.3	0.2	S01020 S01025 S02020 S02025
CCGW040104-2N	4.4	4.3	1.8	2.3	0.4	
CCGW060202-2N	6	6.35	2.38	2.8	0.2	
CCGW060204-2N	6	6.35	2.38	2.8	0.4	
CCGW060208-2N	6	6.35	2.38	2.8	0.8	
CCGW09T302-2N	9	9.525	3.97	4.4	0.2	
CCGW09T304-2N	9	9.525	3.97	4.4	0.4	
CCGW09T308-2N	9	9.525	3.97	4.4	0.8	
CCGW120404-2N	12	12.7	4.76	5.5	0.4	
CCGW120408-2N	12	12.7	4.76	5.5	0.8	
CCGW120412-2N	12	12.7	4.76	5.5	1.2	

DCGW Series (55° Rhombic with 7° clearance angle)

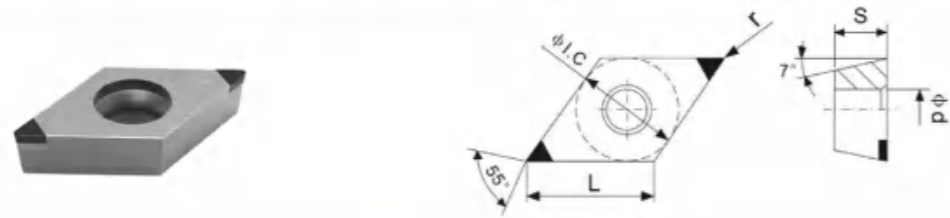

ISO	Dimension					Standard Chamfer
	L(mm)	φ I.C(mm)	S(mm)	φ d(mm)	r(mm)	
DCGW070202-2N	7	6.35	2.38	2.8	0.2	S01020 S01025 S02020 S02025
DCGW070204-2N	7	6.35	2.38	2.8	0.4	
DCGW070208-2N	7	6.35	2.38	2.8	0.8	
DCGW11T302-2N	11	9.525	3.97	4.4	0.2	
DCGW11T304-2N	11	9.525	3.97	4.4	0.4	
DCGW11T308-2N	11	9.525	3.97	4.4	0.8	

VCGW Series (35°Rhombic with 7° relief angle)

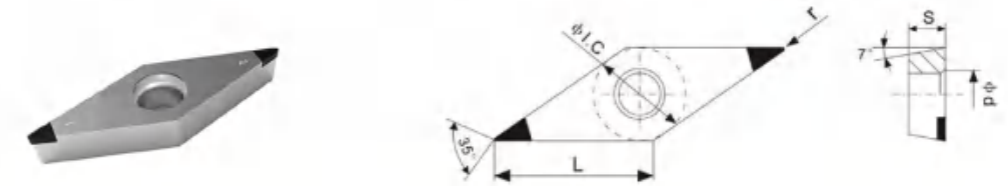

ISO	Dimension					Standard Chamfer
	L(mm)	φ I.C(mm)	S(mm)	φ d(mm)	r(mm)	
VCGW110302-2N	11	6.35	3.18	2.8	0.2	S01020 S01025 S02020 S02025
VCGW110304-2N	11	6.35	3.18	2.8	0.4	
VCGW110308-2N	11	6.35	3.18	2.8	0.8	
VCGW160404-2N	16	9.525	4.76	4.4	0.4	
VCGW160408-2N	16	9.525	4.76	4.4	0.8	
VCGW160412-2N	16	9.525	4.76	4.4	1.2	

VBGW Series (35°Rhombic with 5° relief angle)

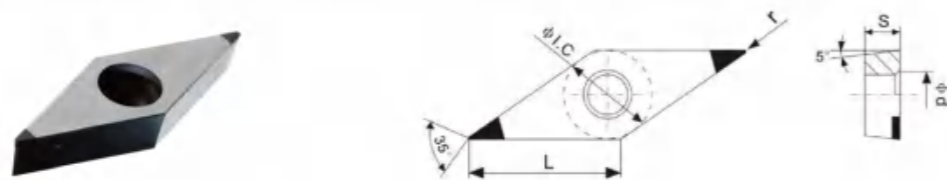

ISO	Dimension					Standard Chamfer
	L(mm)	φ I.C(mm)	S(mm)	φ d(mm)	r(mm)	
VBGW110302-2N	11	6.35	3.18	2.8	0.2	S01020 S01025 S02020 S02025
VBGW110304-2N	11	6.35	3.18	2.8	0.4	
VBGW110308-2N	11	6.35	3.18	2.8	0.8	
VBGW160402-2N	16	9.525	4.76	4.4	0.2	
VBGW160404-2N	16	9.525	4.76	4.4	0.4	
VBGW160408-2N	16	9.525	4.76	4.4	0.8	

TCGW Series (60°Triangle with 7° relief angle)



ISO	Dimension					Standard Chamfer
	L(mm)	φ I.C(mm)	S(mm)	φ d(mm)	r(mm)	
TCGW090204-3N	9	5.56	2.38	2.5	0.4	S01020 S01025 S02020 S02025
TCGW090208-3N	9	5.56	2.38	2.5	0.8	
TCGW110202-3N	11	6.35	2.38	2.8	0.2	
TCGW110204-3N	11	6.35	2.38	2.8	0.4	
TCGW110208-3N	11	6.35	2.38	2.8	0.8	
TCGW16T304-3N	16	9.525	3.97	4.4	0.4	
TCGW16T308-3N	16	9.525	3.97	4.4	0.8	

TPGW Series (60°Triangle with 11° relief angle)



ISO	Dimension					Standard Chamfer
	L(mm)	φ I.C(mm)	S(mm)	φ d(mm)	r(mm)	
TPGW110304-3N	11	6.35	3.18	3.3	0.4	S01020 S01025 S02020 S02025
TPGW110308-3N	11	6.35	3.18	3.3	0.8	
TPGW160304-3N	11	9.525	3.18	4.4	0.4	
TPGW160308-3N	16	9.525	3.18	4.4	0.8	
TPGW16T304-3N	16	9.525	3.97	4.4	0.4	
TPGW16T308-3N	16	9.525	3.97	4.4	0.8	
TPGW16T312-3N	16	9.525	3.97	4.4	1.2	

EXTERNAL TURNING TOOL HOLDER FOR SOLID CBN INSERTS

CRDNN CRDCN CSRNR CCLNR



ISO Code Expression of Indexable External Turning Tool Holder

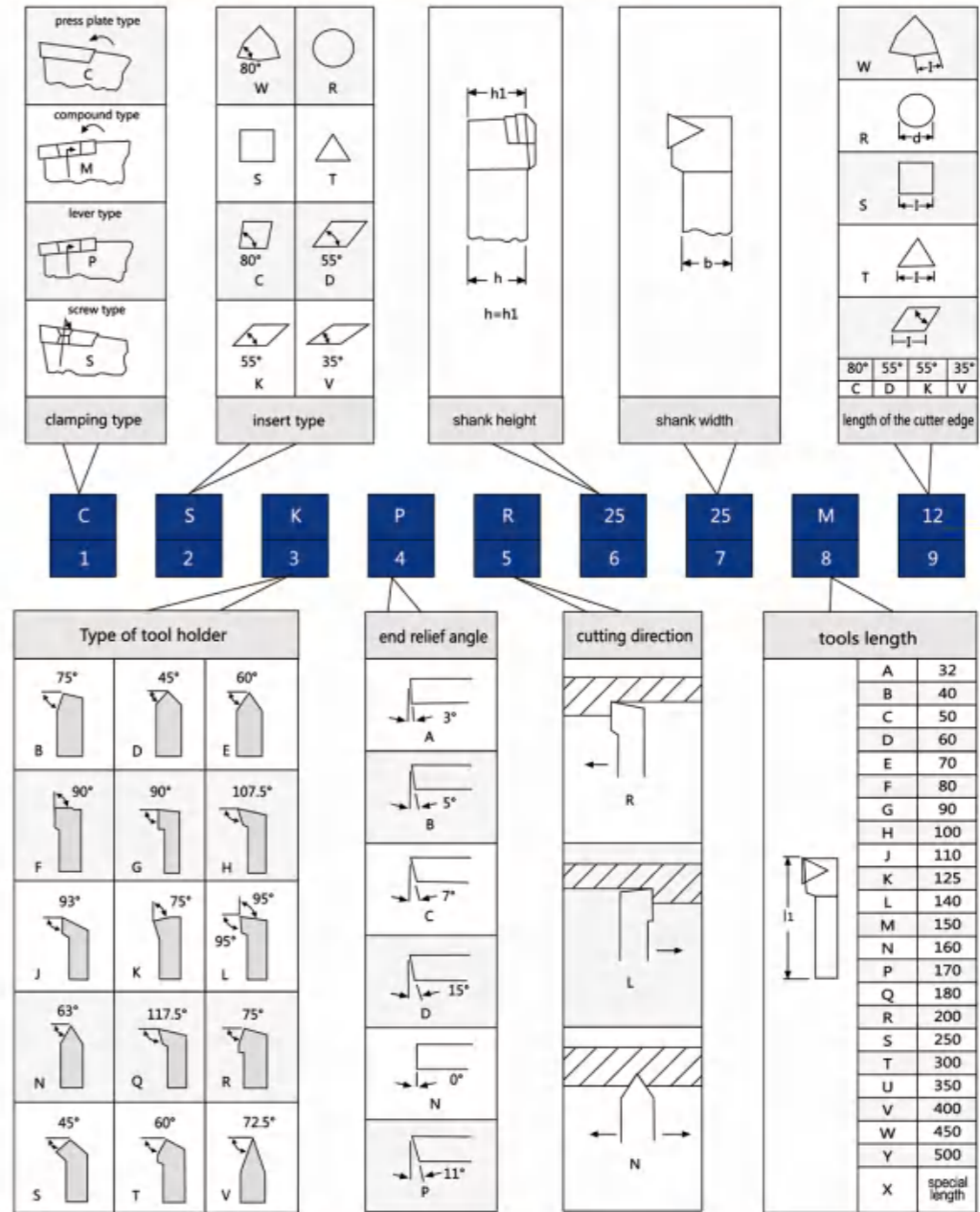

- C** press plate type **M** compound type **P** lever type **S** screw type
- 01** Clamping type **02** Insert Type **03** Type of tool holder
- 04** Primary relief angle **05** Cutting direction **06** Shank Height
- 07** Shank Width **08** Tool holder length **09** Length of the cutting edge

External tool holder for Solid CBN insert

One side tool holder for Round solid CBN insert

Application

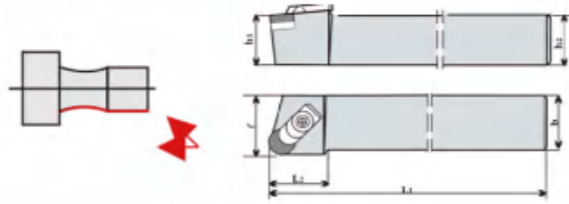

Type	Dimension				Matched insert
	h1=h2	L2	b	L1	
CRGNR/L2020M09	20	30	20	150	RNMN09
CRGNR/L2525M12	25	30	25	150	RNMN12
CRGNR/L3232P15	32	35	32	170	RNMN15
CRGNR/L4040S20	40	38	40	250	RNMN20
CRGNR/L5050T25	50	38	50	300	RNMN25

Middle laying tool holder for Round CBN insert

Application

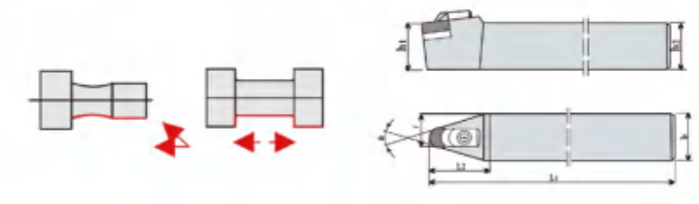

Type	Dimension				Matched insert
	h1=h2	L2	b	L1	
CRDCN2020M09	20	30	20	150	RCMN09
CRDCN2525M12	25	30	25	150	RCMN12
CRDCN3232P12	32	35	32	170	RCMN12
CRDCN4040S15	40	38	40	250	RCMN15
CRDCN5050T15	50	38	50	300	RCMN15

Middle laying tool holder for Round CBN insert

Application

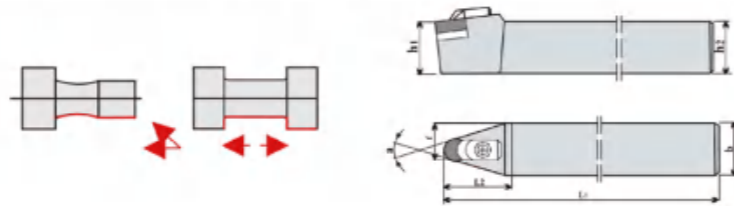

Type	Dimension				Matched insert
	h1=h2	L2	b	L1	
CRDNN2020M09	20	30	20	150	RNMN09
CRDNN2525M12	25	30	25	150	RNMN12
CRDNN3232P15	32	35	32	170	RNMN15
CRDNN4040S20	40	38	40	250	RNMN20
CRDNN5050T25	50	38	50	300	RNMN25

Arc tool holder for grooving

Application

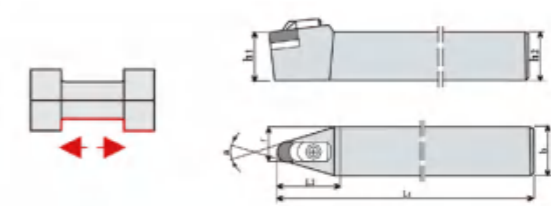

Type	Dimension				Matched insert
	h1=h2	L2	b	L1	
CRDCN2020M06	20	30	20	150	RCMX06
CRDCN2525M09	25	30	25	150	RCMX09
CRDCN3232P12	32	35	32	170	RCMX12
CRDCN4040S15	40	38	40	250	RCMX15
CRDCN5050T19	50	38	50	300	RCMX19

Arc TOOL Holder for Grooving

Application

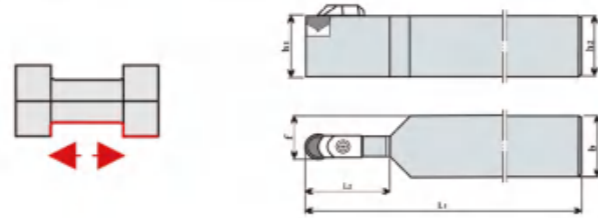

Type	Dimension				Matched insert
	h1=h2	L2	b	L1	
CRDCN2020M06	20	30	20	150	RCMX06
CRDCN2525M09	25	30	25	150	RCMX09
CRDCN3232P12	32	35	32	170	RCMX12
CRDCN4040S15	40	38	40	250	RCMX15
CRDCN5050T20	50	38	50	300	RCMX20

Middle laying tool holder for square solid CBN insert

Application

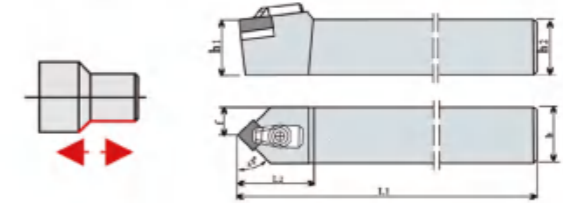

Type	Dimension				Matched insert
	h1=h2	L2	b	L1	
CSDNN2020M09	20	30	20	150	SNMN09
CSDNN2525M12	25	30	25	150	SNMN12
CSDNN3232P12	32	35	32	170	SNMN12
CSDNN4040S15	40	38	40	250	SNMN15
CSDNN5050T20	50	38	50	300	SNMN20

95° tool holder for C-Type solid CBN insert

Application

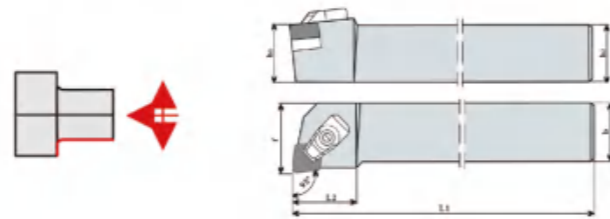

Type	Dimension				Matched insert
	h1=h2	L2	b	L1	
CCLNR/L2020M09	20	30	20	150	CNMN09
CCLNR/L2525M12	25	30	25	150	CNMN12
CCLNR/L3232P12	32	35	32	170	CNMN12
CCLNR/L4040S12	40	38	40	250	CNMN12
CCLNR/L5050T12	50	38	50	300	CNMN12

45° tool holder for square solid CBN insert

Application

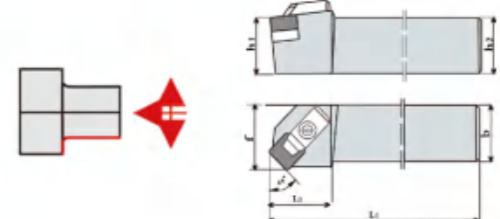

Type	Dimension				Matched insert
	h1=h2	L2	b	L1	
CSSNR/L2020M09	20	30	20	150	SNMN09
CSSNR/L2525M12	25	30	25	150	SNMN12
CSSNR/L3232P12	32	35	32	170	SNMN12
CSSNR/L4040S15	40	38	40	250	SNMN15
CSSNR/L5050T20	50	38	50	300	SNMN20

Front 75° tool holder for square solid CBN insert

Application

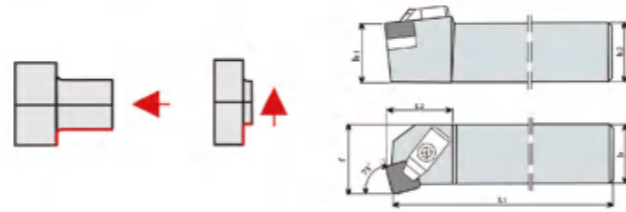

Type	Dimension				Matched insert
	h1=h2	L2	b	L1	
CSKNR/L2020M09	20	30	20	150	SNMN09
CSKNR/L2525M12	25	30	25	150	SNMN12
CSKNR/L3232P12	32	35	32	170	SNMN12
CSKNR/L4040S15	40	38	40	250	SNMN15
CSKNR/L5050T20	50	38	50	300	SNMN20

83° tool holder for square solid CBN insert

Application

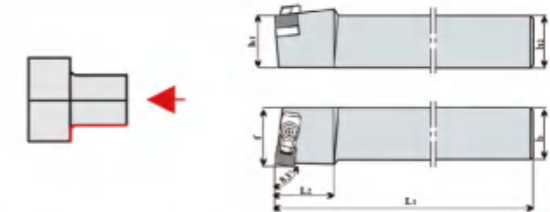

Type	Dimension				Matched insert
	h1=h2	L2	b	L1	
CSXNR/L2020M09	20	30	20	150	SNMN09
CSXNR/L2525M12	25	30	25	150	SNMN12
CSXNR/L3232P12	32	35	32	170	SNMN12
CSXNR/L4040S15	40	38	40	250	SNMN15
CSXNR/L5050T20	50	38	50	300	SNMN20

75° tool holder for square solid CBN insert

Application

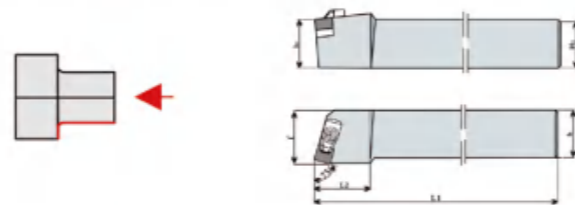

Type	Dimension				Matched insert
	h1=h2	L2	b	L1	
CSRNR/L2020M09	20	30	20	150	SNMN09
CSRNR/L2525M12	25	30	25	150	SNMN12
CSRNR/L3232P12	32	35	32	170	SNMN12
CSRNR/L4040S15	40	38	40	250	SNMN15
CSRNR/L5050T20	50	38	50	300	SNMN20

95° tool holder for D-Type solid CBN insert

Application

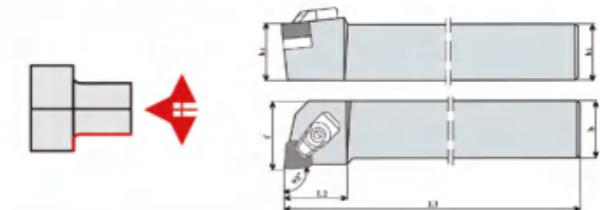

Type	Dimension				Matched insert
	h1=h2	L2	b	L1	
CDLNR/L2020M11	20	30	20	150	DNMN11
CDLNR/L2525M11	25	30	25	150	DNMN11
CDLNR/L3232P11	32	35	32	170	DNMN11

95°External tool holder for W-Type solid cbn insert

Application

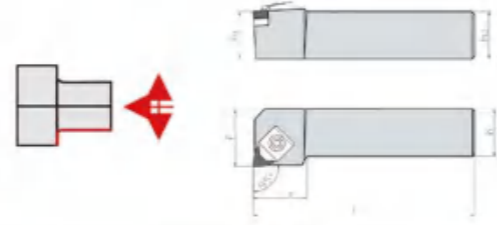

Type	Dimension				Matched insert
	h1=h2	L2	b	L1	
CWLNRL2525M08	25	33	25	150	WNMN08
CWLNRL3232P08	32	35	32	170	WNMN08

Considerations of installing the insert

- 01 Clean the blade and the blade groove thoroughly;
- 02 Check the integrity and wear of the pad
- 03 Check whether the blade pads is reliable
- 04 Check whether the pressuring surface of the Platen is flat
- 05 Make sure the blade close the positioning groove
- 06 Change the blade pad, platen and screws regularly
- 07 Avoid using the worn blade
- 08 Keep the minimum overhang arbor
- 09 Forbid stop suddenly before the tip not cut out in the process

Brake Disc Cutting Tools Solutions



Common CBN Inserts Image For Brake Disc



Recommend Cutting Parameters for Cutting Brake Disc

Cutting Process	Vc (m/min)	Ap (mm)	Fr (mm/r)
Roughing	400~600	< 2.0	< 0.5
Finishing	500~700	< 0.5	< 0.2

INDUSTRY APPLICATION

With more than 10 years experience, SCBN TOOLS have researched so many different CBN Grades specific for different Industries, we can offer you whole solutions for both cast iron and hardened steel in different industries



APPLICATION CASE

Machining Cast Iron Brake Disc

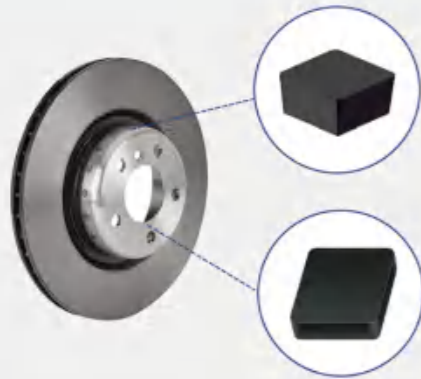

- Solid CBN Inserts CNMN
- Machining Site: End Surface, Cylinder and Inner Bore
- Turning: Rough Machining
- Especially for rough machining, Allowance can reach 3mm
- Solid CBN Inserts SCGN
- Machining Site: End Surface, Cylinder and Inner Bore
- Turning: Finishing Process
- Improve the working efficiency than coating carbide inserts

Machining Cast Iron Brake Drum

- Solid CBN Inserts CNMN and WNMN
- Machining Site: The Inner Bore and Cylinder
- Turning: Both Roughing and Finishing Process
- Can finish both roughing and finishing process with one inserts, no need to change the cutting tools

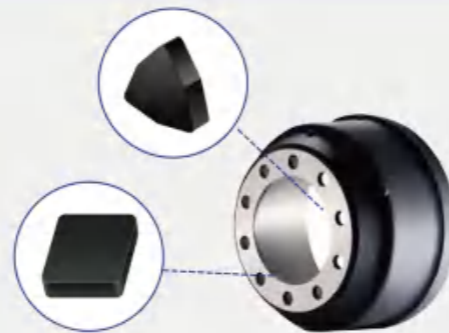

PCBN Inserts MGN & TNGA & VNGA Machining Cylinder Liner

- Machining Site: Groove, Inner Bore, Cylinder
- Process: Turning, Grooving, Boring
- It will have long tool life and high efficiency, Significant improvement in surface roughness compared to coating carbide inserts.



Machining Gray Cast Iron Air Compressor Cylinder



- Brazen PCBN Inserts WNGA
- Machining Site: End Surface
- Boring: Both Roughing and Finishing
- With More cutting edges, it is more economic, and also have stable performance and precision

Machining Cast Iron Flange

- Brazen PCBN Inserts WNGA and SNGA
- Machining Site: End Surface and Cylinder
- Turning: Both Roughing and Finishing
- It can use large cutting margins, and get good quality surface

